

Contents

1 Description and operating principle	3
1.1 Designation.....	3
1.2 Main technical parameters	3
1.3 Package contents.....	5
1.4 Design and operating	7
1.5 Markings.....	11
1.6 Packing	12
2 Safety precautions	13
3 Preparing for use and proper use	14
3.1 Safety precautions during preparing and proper use	14
3.2 Preparing for proper use	14
3.3 Proper use	17
4 Technical maintenance	30
5 Troubleshooting	31
6 Attestation	32
6.1 Performing attestation	32
6.2 Attestation facility	32
6.3 Safety requirements during attestation	33
6.4 Attestation conditions.....	33
6.5 Preparing to attestation	33
6.6 Attestation performing.....	34
6.7 Registering attestation results	40
7 Storage	41
8 Transportation	42
9 Certificate of acceptance	43
10 Warranty	44

The purpose of the User Manual is providing information for proper operation of the transformer oil breakdown voltage tester UIM-90 (220) (hereinafter – Tester) and is the main source of operating instructions.

The User Manual contains information on the purpose, contents, technical specification, design and operating principle of the Tester and its units as well as its tools, marking, sealing and packaging.

The User Manual contains information necessary to prepare the Tester for operation as well as to perform its maintenance, and stipulates the order in which these procedures are to be done.

The Tester is manufactured according to technical conditions of the Manufacturer TU U33.2-14102968-003-2002.

1 Description and operating principle

1.1 Designation

1.1.1 The purpose of the Tester is measuring breakdown voltage of transformer oil and other insulating liquids in accordance with GOST 6581-75 (CT SEV 3166-81).

1.1.2 The design of the Tester includes a built-in radio channel, to connect to a PC for storing, processing and printing the results of tests.

1.1.3 The Tester is portable equipment.

1.2 Main technical data

1.2.1 The main technical data of the tester are shown in Table 1.

Table 1

Type	Value
1 Range of testing voltage (rms value), kV	from 10 to 90
2 Relative voltage measurement error, %	±3
3 Volume of measuring cell, cm ³ , max	400
4 Operating alternating voltage, V	220 ⁺¹⁵ ₋₁₀
5 Power supply frequency, Hz	50/60
6 Power consumption, kV×A, max	0,5
7 Weight, kg, max	30
8 Dimensions, mm, min	520×335×320

1.2.2 Duration of continuous work of the tester – 8 hours.

1.2.3 Tester operates, retaining the design and parameters during and after exposure to external influencing factors, as indicated in Table 2.

Table 2

Factor	Values of factors		
	Operating conditions	Extreme conditions	
		Transportation	Storage
1 Ambient temperature, °C – lower value – upper value	15 35	minus 25* 55	minus 25* 55
2 Relative humidity, %, max	80	85	85
3 Atmospheric pressure, mm Hg – lower value – upper value	630 795	630 795	630 795
4 Shockproof on multiple shocks – peak shock acceleration, m×sec ⁻² – duration of shock acceleration, ms – quantity of shocks, psc.		30 1 80-120	

* Operating the Tester after prolonged exposure to temperatures below 5°C allowed for after preincubation for 4 hours at a temperature of from 15°C to 35°C

1.3 Package contents

1.3.1 Package contents listed in Table 3.

Table 3

Markinge	Item	Qty	Serial	Note
"UIM.100.000.000"	Testing device	1		
"UIM.200.000.000"	Measuring cell	1		
"UIM.300.000.000"	Power supply cable	1		
"UIM.400.000.000"	Remote control	1		
"UIM.500.000.000"	Grounding wire	1		
"UIM.600.000.000"	Transport crate	1		
"UIM.000.000.001"	Template caliber	1		
"UIM.000.000.002"	Activating rod	1		
–	Sticks for manual stirring	2		
	Bluetooth adapter	1		Optional (standard for 220 series)
	Software disc "VirtualUIM"	1		Optional (standard for 220 series)
"UIM.000.000.000 SM"	Software user manual "VirtualUIM"	1		Optional (stan- dard for 220 se- ries)
VP-1-1-5A OUO.480.003TY	Thermal fuse	1		
VP-1-1-2A OUO.480.003TY	Thermal fuse	1		
"UIM.000.000.000 UM"	User Manual	1		

1.3.2 List of customizable settings of tester parameters and ranges of changing its values given in table 4.

Table 4

No	Parameter	Range of values	Leap
1	Radio connection (Bluetooth)*	–	On/Off
2	Stirring	–	On/Off
3	Quantity of breakdowns N, psc.	from 1 to 20	1
4	Time of stirring Ts, sec	from 10 to 1000	10
5	Settling time after filling the cell Tsf, sec	from 0 to 1200	60
6	Settling time after stirring Tss, sec	from 0 to 1200	60
* 220 series			

1.4 Design and operating principle

1.4.1 The Tester operates in two modes – manual and automatic. In manual mode operator performs all actions manually. In automatic mode, the unit performs a series of operations in accordance with a predetermined algorithm (tested in accordance with GOST, or in accordance with specific requirements or standards).

The device includes a high-voltage stand 1, measuring cell 2, remote control 3, power supply cable 4, grounding wire 5, activating rod 6 and template-caliber 12 (see figure 1).



Figure 1

1.4.2 The Tester has a test compartment 7, which holds a measuring cell 2 to test the dielectric fluids. Test compartment 7 closed by a cover 8 which is connected with the lock which prevents the high voltage supply when it is open.

The Tester has a compartment 7 for mounting measuring cell 2 in it for insulation liquids tests. Test compartment 7 has a lid 8 which is connected with the lock which prevents the high voltage supply when it is opened.

At the bottom of the test chamber for measuring cell (hereinafter-cell) installed a device for mixing the sample of insulation liquids after a breakdown. Design of the Tester allows stirring of insulations liquids in both manual and automatic modes.

1.4.3 To the left of test compartment located control panel 9, which contains following control elements and indication (see figure 2):

1 – LCD display, for displaying status of the Tester, operating modes and parameters of tests;

2 – green LED indicator , which indicates power supply on;

3 – red LED indicator , which indicates high voltage supply on the electrodes;





4 – power switch 

5 – button  for initiating Tester work;

6 – button  for interruption of Tester work in manual mode for starting stirring procedure of insulation liquid;

7 – button  for selection of operating mode (manual/automatic);

8 – button  for delay in increasing of high voltage.

Buttons , , ,  may have different functions in different operating modes of the Tester.

1.4.4 Under the test compartment is located generator device filled with transformer oil. Its sealing is carried out with a rubber gasket. To control the level of transformer oil and, if necessary, topping it on the cover of the generator located two plugs 10.

1.4.5 Test voltage from the transformer, located in the generator unit, feed two high voltage electrodes 11 which are also act as a support for the installation of the cell.

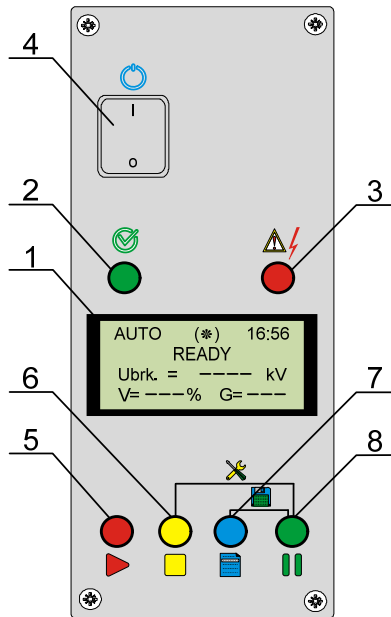

Figure 2

1.4.6 Remote Control 3 (see figure 3) purpose is only for certification works of the Tester (primary or periodical).

1.4.7 Power supply cable 4 for connection the Tester to power network.

1.4.8 Grounding wire 5 for grounding the Tester during operation.

1.4.9 Reference caliber 12 for control gap between test electrodes in cell. Operating surfaces of reference caliber must be clean and smooth without nicks and dents.

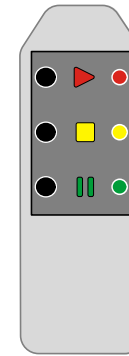

Figure 3

1.4.10 Activating rod 6 for stirring of insulating liquid sample.

1.4.11 Rear panel of the Tester has (see figure 4):

1 – socket ~ 220 V for connecting network power supply cable of the Tester;

2 – thermal fuses carrier (2A and 5A);

3 – terminal \perp for connecting grounding wire.

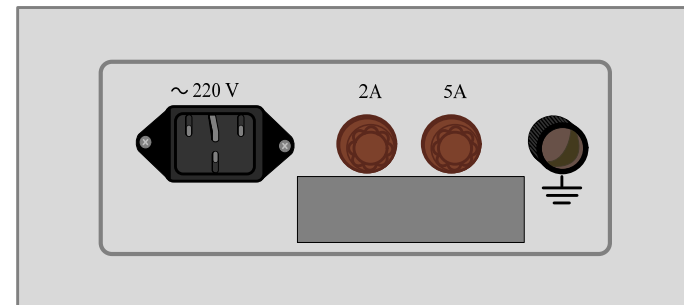

Figure 4

1.5 Marking

1.5.1 The Tester has following markings:

- model name;
- serial number;
- manufacturing date.

1.5.2 The plate with markings located on the rear part of the Tester.

1.6 Packaging

1.6.1 The Tester is packed in transportation crate, which prevents shocks and damages during transportation and storage.

1.6.2 Before packing the Tester in the packing crate be sure that generator plug closed properly in order to prevent transformer oil leakage.

1.6.3 Each separate unit of the device is wrapped with waxed paper DSTU GOST 9569, paraffin or polyethylene and wrapped in packing crate in a way that all empty space between the components and walls of packing crate were densely filled with shock absorbing materials.

1.6.4 User Manual is wrapped along with the Tester inside the packing crate.

2 Safety requirements

2.1 Workplace of service personnel must comply with the fire safety requirements in accordance with GOST 12.1.004-91.

2.2 The insulation resistance of power circuits, with respect to the housing panels of the Tester must not be less than 20 MOhm.

2.3 In case of simultaneous operation of several Testers the distance between them must be at least 3 m.

3 Preparation for use

3.1 Safety precautions

3.1.1 The Tester is to be operated by electrotechnical staff of at least two persons over 18 years old, who are allowed to operate devices with voltage over 1000 V, who have undergone a medical check-up as well as briefing on labour and health protection.

3.1.2 When operating the device, the Tester body must be grounded with grounding wire.

WARNING! OPERATION WITHOUT GROUNDING IS PROHIBITED!

3.1.3 The installation or removal of the test cell with insulating liquid is to be done only after turning off the tester power switch .

3.1.4 Operate the Tester only standing on rubber carpet.

WARNING! OPERATING A FAULTY TESTER (INDICATION AND BLOCKINGS) IS PROHIBITED!

3.2 Preparation for use

3.2.1 Do the following before operating the Tester:

- a) check the package contents listed in table 3 of present User Manual;
- b) take the Tester out of the packing crate and wipe conserving grease on metal parts;
- c) wipe generator panel, electrodes, cell, reference caliber with clean serviette with benzene or similar liquid and after clean again with dry serviette;

d) check transformer oil level in generator unit. Its level must be 4-8 mm lower the upper cap of generator unit. If necessary fill up transformer oil with breakdown voltage more than 45 kV, unscrewing plug on the cap of generator unit;

e) unscrew 2-3 turns plugs of generator unit, in order to allow transformer oil freely vary the volume;

f) check the position of power switch . It must be turned "O";

g) connect terminal  to a grounding using protective grounding wire.

ATTENTION! THE TESTER MUST NOT BE SWITCHED ON WITHOUT PROPER GROUNDING!

h) connect power cable to a socket ~ **220 V** on the rear part of the Tester.

3.2.2 Preparing the cell to work, perform following actions:

a) remove the rust-preventing grease with a cloth moistened with benzene or kerosene.

To wash the cell filled with insulating oil, use sequentially kerosene in accordance with GOST 18499 and petroleum ether according to GOST 11992 with boiling range limits from 80°C to 120°C; cell, which were filled with en-chlorination and fluorinated hydrocarbons, as well as organosilicon liquids-sequentially toluene according to GOST 9880, trichlorobenzene or acetone; cell filled with castor oil, – use acetone GOST 2603. When using low-boiling solvents, resulting rapid evaporation, the electrodes can be cooled, and on their surface possible condensation. In such cases, heat the cell slightly. Periodically clean the surface of the electrodes using polishing materials. After polishing remove polish stains thoroughly by washing with mentioned above solvent;

b) check the condition of electrodes. In cases when visually observed darkening of electrode surface, dismantle these electrodes, polish it, wipe with solvent and again mounted;

c) rinse after treatment mentioned above, the cell with the liquid under test and then fill the cell with a portion of the liquid to be tested. In cases when the control of daily control, acceptance and other tests and liquid dielectric breakdown voltage value is lower the established standards, the processing of cell reducing to its rinsing with the insulation liquid under test. Non-operating the cell keep it filled with liquid dielectric. Breakdown voltage of such liquid must be within the standards for this type of liquid dielectric;

d) check the gap between the electrodes of the cell. If the working surface of the reference caliber "YES" passes freely in the gap, and the working surface "NO" does not pass, the gap is set correctly. Otherwise necessary to adjust the gap and check it again.

3.2.3 preparing the sample dielectric liquid for use, perform following actions:

a) fill one jar from the container (containers) for storage sample of liquid dielectric. One portion of liquid dielectric considered part of sample, which poured into the cell;

b) before testing, the tightly closed vessel containing the insulating liquid sample should be kept in the testing premises until it reaches the ambient temperature, but no less than 30 minutes. During this time the vessel is to be protected from direct daylight;



c) the vessel containing the liquid electrical insulator sample is to be carefully turned upside down several times, so that occasional impurities are equally distributed throughout the whole liquid electrical insulator. When doing this, avoid intensive shaking to prevent air bubbles from forming in the liquid electrical insulator. Immediately after, the test cell, including the electrodes, is rinsed with a small amount of the liquid electrical insulator, following which the test cell is slowly filled taking care not to let the liquid electrical insulator trickle down its side and ensuring no air bubbles are formed.

If air bubbles formed, remove it by gentle stirring with rod for hand stirring. The breakdown voltage of liquid insulating materials defined at temperatures of from 15°C to 35°C.

3.3 Proper use

3.3.1 Operating the Tester in manual mode do the following:

a) connect power supply cable to a power network;

b) set the power switch  in position "I". Green LED indicator  must light up in green. LCD display will show on of these screenshots:

light up in green. LCD display will show on of these screenshots:

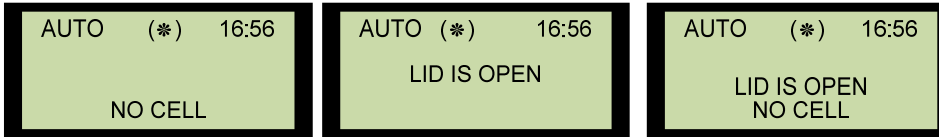

- 1) in case of absence of mounted measuring cell;
- 2) in case of opened lid on test compartment;
- 3) both 1 and 2: absence of measuring cell and opened lid;

c) mount the test cell with insulating liquid on proper high voltage outputs inside the test compartment. Immerse activating bar to the bottom of the cell. Close test compartment lid. LCD display will indicate following:

inside the test compartment. Immerse activating bar to the bottom of the cell. Close test compartment lid. LCD display will indicate following:

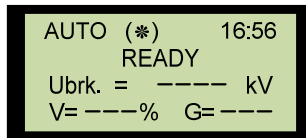

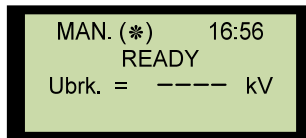

d) press and release button  to select manual operating mode. LCD display will show MAN.:

display will show MAN.:





e) set necessary stirring time of insulating liquid:

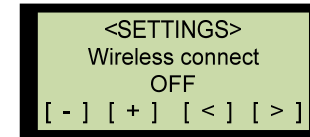

– press and hold pressed (during 3-5 seconds till the sound beep) simultaneously buttons  and , display will show inscription. This inscription only appears if Bluetooth module installed:

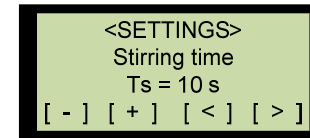

– press and release button  until appearing inscription on the LCD display:





– press and release button  until appearance inscription with setting of time of stirring (time of stirring may be selected from 10 up to 1000 sec with interval 10 sec);

– press and hold pressed (during 3-5 sec) simultaneously buttons  and ,

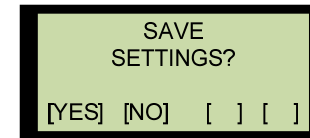
LCD display will show:





– press and release button  – if "YES" and button  – if "NO";

f) press and release button  to enter manual operating mode. LCD display will show MAN.:

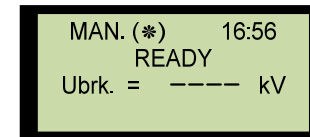
display will show MAN.:



g) press after 10 minutes when cell is filled button , red LED indicator  will light up and display will show:



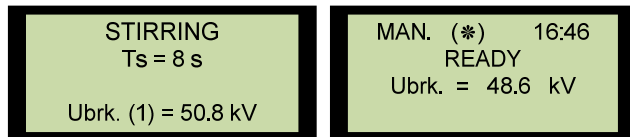

and then inscription U= with changing value of breakdown voltage;

h) after breakdown of liquid insulator red LED indicator  will turn off, and LCD display will show sequentially following inscriptions:





i) in case of need perform iterated tests of liquid dielectric. Repeat actions of article "g" and "h". Of present paragraph;

j) set power switch  in position "O", green LED indicator  will turn off. Unplug power cable from the network socket.

3.3.2 Operating the tester in automatic mode (according to GOST 6581-75) perform the following:

a) connect the Tester with power supply cable to a power network. Selecting automatic operation mode according to GOST 6581-75 (ST SEV 3166-81) following parameters setting up automatically:

- Stirring – turned "ON";
- Number of breakdowns N = 6;
- Time of stirring Ts = 10 sec;
- Settling time after filling the cell Tsf = 600 sec;
- Settling time after stirring Tss = 300 sec;

b) set the power switch  in position "I". Green LED indicator  must light up in green. LCD display will show on of these screenshots:

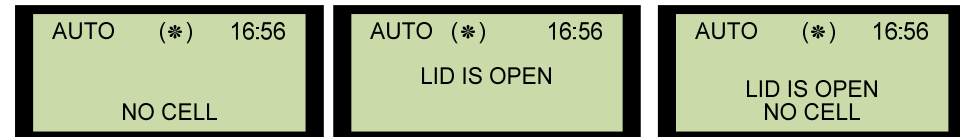

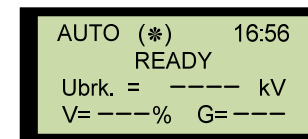

- 1) in case of absence of mounted measuring cell;
- 2) in case of opened lid on test compartment;
- 3) both 1 and 2: absence of measuring cell and opened lid

c) mount the test cell with insulating liquid on proper high voltage outputs inside the test compartment. Immerse activating bar to the bottom of the cell. Close test compartment lid. LCD display will indicate following:



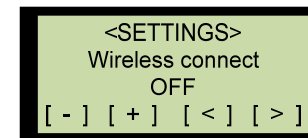

d) set testing according to GOST 6581-75 (CT SEV 3166-81) with following actions:

- press and hold pressed (during 3-5 seconds till the sound beep) simultaneously buttons  and , LCD display will show inscription. This inscription only appears if Bluetooth module installed:



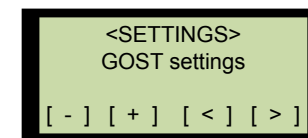

- press and release button  until appearance inscription on the LCD display SETTING the GOST settings:

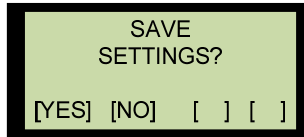

– press and hold pressed (during 3-5 sec) simultaneously buttons  and , LCD display will show:



– press and release button  – if "YES" and button  – if "NO";

e) press and release button . The Tester will perform testing in automatic mode according to GOST 6581-75 (CT SEV 3166-81);

f) after finishing testing LCD display will show:

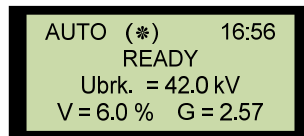



g) the tester after finishing testing automatically calculates:

- average value of breakdown voltage, Ubrk.;
- mean square error, G;
- standardized value of relative variance, V (SVRV);

h) if standardized value of relative variance V not exceed 20 %, then result of tests considered reliable and LCD display will show READY;

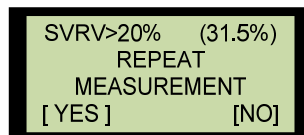

i) if standardized value of relative variance V not exceed 20 %, then LCD display will show following inscription:





j) if measurements are no necessary to repeat, then press and release the button , the LCD displays READY. If you want to repeat measurements, then press and release the button , the LCD displays CHANGE SAMPLE:



k) open the test compartment lid, remove the cell from the test compartment and replace the sample of dielectric liquid, taken from the same jar as the previous sample, set the cell, close the lid and press the button . Tester will perform six additional breakdown tests and calculate the average breakdown voltage value of 12 breakdowns, average squared error, standardized value of variation coefficient;

l) set the power switch  in position "O", green LED indicator  will light off. Disconnect the Tester from power network.

3.3.3 Operating the Tester in automatic mode with presets which differ from GOST requirements, operator can input required parameters of a standard manually. For this, perform following actions:

- a) connect the Tester to a power network;
- b) set the power switch  in position "I". Green LED indicator  must light up in green. LCD display will show on of these screenshots:

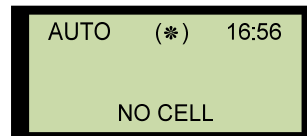

1) in case of absence of mounted measuring cell;

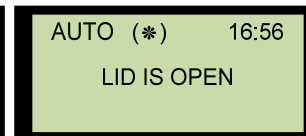

2) in case of opened lid on test compartment;

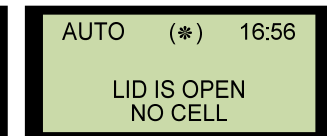

3) both 1 and 2: absence of measuring cell and opened lid;

c) mount the test cell with insulating liquid on proper high voltage outputs inside the test compartment. Immerse activating bar to the bottom of the cell. Close test compartment lid LCD display will indicate following:

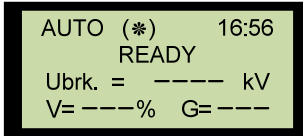

d) set required parameters of the test according to standard or requirements, for this:

– press and hold pressed (during 3-5 sec till the sound beep) simultaneously buttons and , LCD display will show inscription. This inscription only appears if Bluetooth module installed:



– press and release button until appearing inscription on the LCD display:

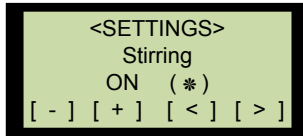

– if necessary to turn off stirring – press and release button ;

– press and release button , LCD display will show:

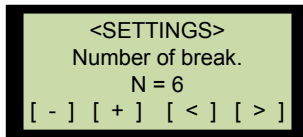

– pressing and releasing button or button set required quantity of breakdowns;

– press and release button , LCD display will show:

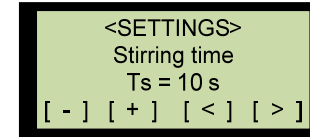

– pressing and releasing button or button set required time of stirring;

– press and release button , LCD display will show:

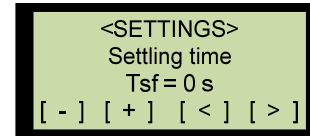

– pressing and releasing button or button set required time of settling after filling up of the cell;

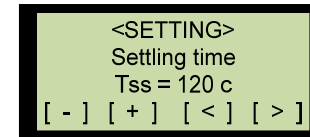

– press and release button , LCD display will show:



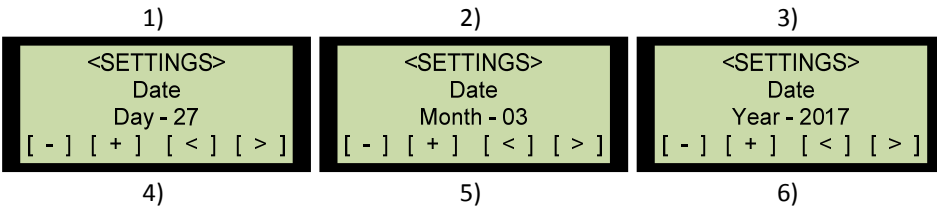
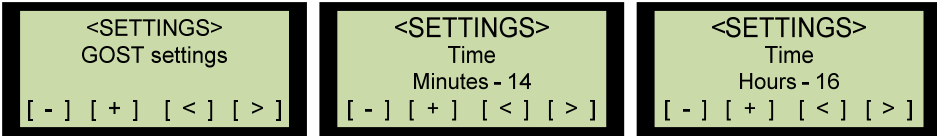

– pressing and releasing button or button set required time or settling after stirring;



– sequentially press and release button , LCD display will show following inscriptions:



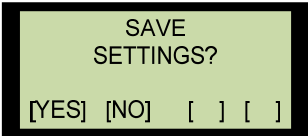

– the parameters described in previous article can be changed by pressing and releasing the button  or the button ;

– press and hold pressed (during 3-5 sec) simultaneously button  and button , LCD display will show:

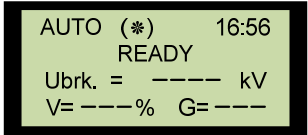

– press and release button  – if "YES" or button  – if "NO". LCD display will show following:



– press and release button . The Tester will perform tests according with new specified requirements;

e) after completion of tests LCD display will show:

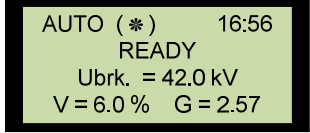



f) the tester after finishing testing automatically calculates:

- average value of breakdown voltage, Ubrk.;
 - mean square error, G;
 - standardized value of relative variance, V (SVRV);
- g) if standardized value of relative variance V not exceed 20 %, then result of tests considered reliable and LCD display will show inscription READY;

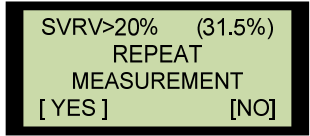

h) if standardized value of relative variance V not exceed 20 %, then LCD display will show following inscription:



i) if measurements are no necessary to repeat, then press and release the button , the LCD displays READY; If you want to repeat measurements, then press and release the button , the LCD displays CHANGE SAMPLE:



j) open the test compartment lid, remove the cell from the test compartment and replace the sample of dielectric liquid, taken from the same jar as the previous sample, set the cell, close the lid and press the button . Tester will perform additional set quantity of breakdown tests and calculate the average breakdown voltage value, average squared error, standardized value of variation coefficient;



k) set the power switch  in position "O", green LED indicator  will light off. Disconnect the Tester from power network.

3.3.4 To read test results do the following:

a) after tests press and release button , LCD display will show following info:

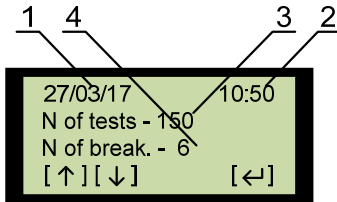
- 1 – date of tests;
- 2 – end time of test;
- 3 – serial number of test;
- 4 – quantity of beakdowns;



b) to view all other results press and release buttons  or . Following information will be displayed:

- 5 – average value of breakdowns;
- 6 – standardized value of variation coefficient;
- 7 – calculated value of mean square error;
- 8-13 – values of breakdown voltages U1-U6 respectively;

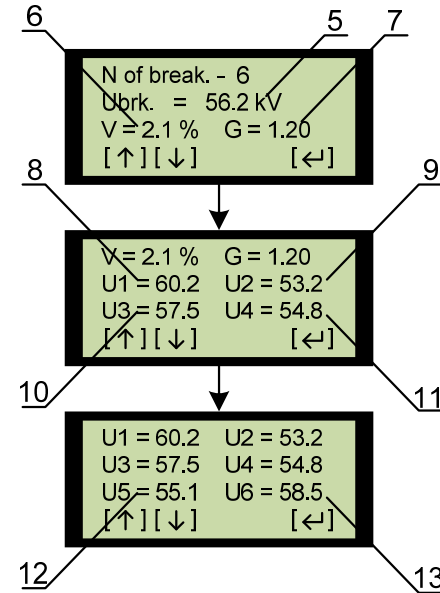

c) press and release button  to finish viewing the test results.

3.3.5 Operating the Tester by PC use software "VirtualUIM" User Manual "UIM.000.000.000 SM".

3.3.6 Processing of test results

3.3.6.1 Each sample of liquid dielectric should be performed six breakdowns.

3.3.6.2 Average value of breakdown voltage is calculated by the formula:

$$U_{bd} = \frac{1}{n} \sum_{i=1}^n U_{bd,i} , \tag{1}$$

where $U_{bd,i}$ – value of breakdown voltage, obtained during sequential breakdowns, kV;

n – quantity of breakdowns.

Average squared error σ_u of average value of breakdown voltage is calculated by the formula:

$$\sigma_u = \sqrt{\frac{\sum_{i=1}^n (U_{i0,i} - \bar{U}_{i0})^2}{n(n-1)}}. \quad (2)$$

3.3.6.3 Value of breakdown voltage must correspond with standardized value of variation coefficient V, calculated by the formula:

$$V = \frac{\sigma_u \cdot 100}{\bar{U}_{i0}}. \quad (3)$$

3.3.6.4 If the value of variation coefficient exceeds 20 %, then in this case test cell filled again with portion of liquid from the same jar with liquid sample (after its stirring), perform 6 evaluations of breakdown for calculation by formulas (1) – (3) quantity of breakdowns n taking 12. If coefficient of variation exceeds 20 %, quality of dielectric can be considered as unsatisfactory.

4 Technical maintenance

4.1 With the manufacturing, during the operation and after the repair, Tester is subject to certification. Certification of Tester, at least once a year. Certification is carried out using the instruments and methods listed in Section 6 Certification.

4.2 Technical maintenance is carried out once in 12 months.

4.3 Performing technical maintenance it is necessary to:

a) check oil level in generation unit. Level must be 4-8 mm lower than the cap of generator unit. If necessary fill up the transformer oil with breakdown voltage not lower than 45 kV;

b) check the condition of electrodes in the cell. If electrodes have nicks and dents, deep scratches on its surface, which are not removed during polishing, such electrodes must be replaced;

c) clean insulating surface of high-voltage conclusions and lid of the test compartment from dust with a dry serviette TU 31-835.



4.4 At least once in two years is necessary to determine the breakdown voltage of transformer oil in the generator unit. If the breakdown voltage below 35 kV, the oil must be replaced. The replacement perform in vacuum. Breakdown voltage of oil refilled should not be less than 45 kV.

4.5 In case pouring of liquid dielectric inside the testing compartment, its bottom should be wiped dry with a clean cloth and then – a cloth moistened with Rectified ethyl sprit technical grade "extra" GOST 18300.

5 Maintenance

5.1 The list of possible faults during operation of the Tester, and troubleshooting is shown in Table 5.

Table 5

Fault	Probable cause	Remedy	Note
1 After pressing power switch  – green LED indicator  does not turn on	1 Fuse 2A blown	1 Replace fuse	
2 By pressing button  , voltage does not raise and LCD display shows U (1) = 0.5 kV	1 Fuse 5A blown	1 Replace fuse	
3 After breakdown LCD display shows dashes instead of numbers. Set does not react when pressing the control buttons	1 Network voltage fluctuations	1 Turn off the Tester and then turn on	
	2 Exposure to electromagnetic-magnetic-interference	1 Turn off the Tester and then turn on 2 Increase the distance between Testers which work simultaneously.	
4 Built-in radio channel Bluetooth unit is working, but the results are not displayed on the PC	1 Tester is not connected to PC properly 2 Error in "VirtualUIM" software	1 Check connection with the PC and restart program according to the User Manual UIM-90 (220)	

5.2 Other malfunctions can be eliminated only by the manufacturer.

6 Attestation

6.1 Attestation actions

6.1.1 During attestation following actions must be performed according to table 6.

Table 6

Name	Paragraph of methodics	Attestation	
		Unscheduled Attestation	Scheduled Attestation
1 Visual inspection	6.6.1	no	yes
2 Testing	6.6.2	yes	yes
3 Check insulation resistance of power circuits relative to the housing	6.6.3	yes	–
4 Checking reduced error of measurement of the test voltage	6.6.4	yes	yes

6.2 Attestation means

6.2.1 During the Tester Attestation should be applied measuring instruments listed in the table 7.

Table 7

Paragraph of methodics	Name of a measuring instrument, the main metrological and technical characteristics
6.6.3	Megaohmmeter M4100/3 voltage 500+50 V, accuracy class 1
6.6.4	Kilovoltmeter C100, Phenix three ranges electrostatical GOST 8711 (IEC 51-2-84)

6.2.2 Measuring devices are used in the attestation shall have a certificate of calibration.

6.2.3 It is allowed to use other means of measurements with the same metrological characteristics indicated in the table 7.

6.3 Safety requirements during attestation

6.3.1 Attestation of Tester is only allowed to persons who studied the technical documentation for the Tester, User manuals for measuring instruments and who passed an appropriate test of knowledge of safety rules.

6.4 Terms of certification

6.4.1 Attestation of the Tester is carried out in operating conditions of use.

6.5 Preparation for attestation

6.5.1 Check the measuring instruments in accordance with the attestation requirements of table 7, operational documentation necessary elements of interconnection.

6.5.2 Prepare measuring instruments for attestation to work in accordance with the requirements of the operational documentation.

6.6 Attestation

6.6.1 External visual inspection



6.6.1.1 Perform external examination of Tester for compliance with the following requirements:

- the case of the Tester, remote control, power cord and grounding wire should be without mechanical damage;
- labeling must be clear;
- identification of controls must comply with the technical documentation;
- package contents of the tester must meet the technical documentation for it.

6.6.1.2 A further attestation is allowed if the external survey found no violation of the above requirements and have available all documents required for attestation.

6.6.2 Testing

6.6.2.1 During the testing of breakdown tester, perform the following:

- a) verify the position of the power switch , it must be in the "O" position;
- b) the terminal  of the Tester connect to the protective grounding using grounding wire.

CAUTION! OPERATION WITHOUT GROUNDING IS PROHIBITED!

- c) connect the power cable to the socket ~ **220 V** on the rear panel of the Tester;



d) perform clauses a-d of subsection 3.3.1;

e) slightly open the lid of the test compartment at an angle about 30° to 40°.

Ensure that increasing of the high voltage is stopped, the red LED indicator  turns off and LCD display shows inscription lid opened;

f) set the power switch  to "O" and remove the cell from the test compartment;

g) close the lid of the test compartment, and set the power switch  to "I" position. Make sure that the LCD displays inscription NO CELL;

h) press and release the button . Make sure that the high voltage is not increasing, and the red LED indicator  is off;

i) set the power switch  to "O".

6.6.2.2 The test results are considered positive, and the Tester is allowed for further operation, if:

a) there were no any failure during actions mentioned in previous clause;

b) all LED indicators were "ON" and "OFF";

c) the blocking which prevents the supply of high voltage triggered by opening the cover of the test compartment.

6.6.3 Checking the insulation resistance of power circuits relative to the casing

6.6.3.1 Testing of electrical insulation of power circuits relative to the casing carry out in the following way:

a) connect the power supply cable to the Tester;

b) disconnect the grounding wire from the Tester;

c) connect Megger M4100/3 to the terminal  and to one of the outputs of the power supply cable;

d) perform insulation resistance measurement;

e) disconnect Megger M4100/3.

6.6.3.2 Checking the insulation resistance of power circuits relative to the casing is considered positive if its value matches the specified.

6.6.4 Verification of reduced error of measurement of the test voltage

6.6.4.1 Verification of reduced error of measurement of the test voltage carried out as follows:

a) prepare operating the Tester in accordance with the User manual;

b) set the installation on a test field over the guard to prevent accidental touch or approach the dangerous distance personnel to high voltage outputs.

CAUTION! POWER SWITCH  MUST BE SET TO "O". POWER CABLE NOT CONNECTED TO POWER LINE!

c) connect the terminal \perp using the grounding wire to the protective grounding.

CAUTION! OPERATION THE UIM TESTER WITHOUT GROUNDING IS PROHIBITED!

d) remove the side and back housing from the high-voltage stand. Remove the lid lock connector X7 and set the jumper (see figure 5). Connect remote control to the X2 socket (see figure 6);

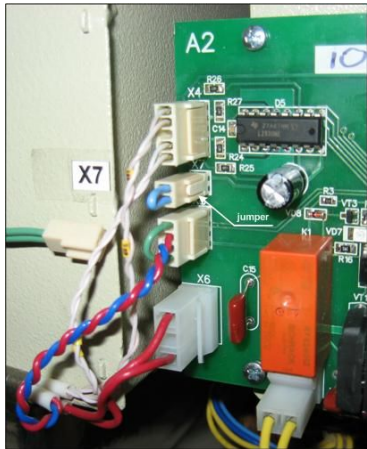

Figure 5

e) open the lid of the test compartment;

f) take empty cell and using a wrench move apart electrodes of the cell at the maximum distance;

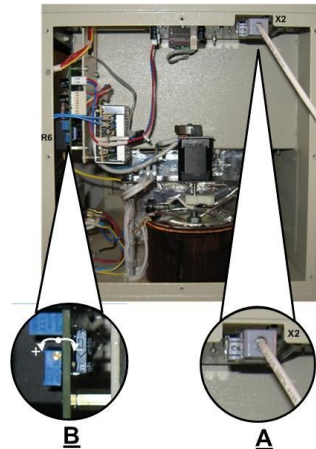

Figure 6

g) attach a high-voltage output of the C100 (or Phenix) kilovoltmeter to one of the electrodes of the cell by means of a segment of high-voltage cable with insulation, rated at no less than 70 kV, or a metal pipe with an outside diameter cross section of no less than 25 mm. In the latter case it is necessary to provide insulating gaps between the surface of the metal pipe and the casing of the Tester at least 100 mm. To prevent corona, surfaces of conductors and fasteners should not have sharp edges, dents, sharp, etc. Operating Tester avoid radial loads on high voltage outputs;

h) fill the cell with transformer oil GOST 982-80 with a breakdown voltage of no less than 45 kV and install it on the high-voltage outputs;

i) without connecting the power cord to the power supply line, set the power switch \odot in position "I". Take out the remote control and the power cord socket beyond the security fence;

j) close the door of protective fencing. All subsequent switching perform using the remote control;

k) connect the power supply cable to the power supply line by setting it 220 V. The front panel should light up with green LED indicator \odot and on the remote control – yellow LED indicator \square ;

l) press and release the button \blacktriangleright on the remote control. At the same time on the remote control must light up a red LED indicator. High voltage on the electrode of the cell will increase. The current value of the voltage control by kilovoltmeter C100 (or any other). Reaching value $30^{+0.2}_{-0.25}$ kV stop increasing of voltage kV on the electrode by pressing and holding pressed button \square on the remote control. Note the readings on the display and on kilovoltmeter;

m) press and release the button  on the remote control. Unplug the power supply cable from the power supply line;

n) connect kilovoltmeter to another electrode and repeat operations from "j" to "m";

p) summarize the values on the indicator and kilovoltmeter when measuring the voltages on two electrodes of the cell. Determine the reduced measurement error of the test voltage at a certain numerical mark;

r) in the case of differences between the values of reduced error and specified. Unplug the power cable from the power supply line and make adjustment of an embedded device, which measures test voltage, using the trimmer R6 (see figure 6);

s) repeat the operation from "g" to "r";

t) repeat the operation from "f" to "s" for voltages $10_{-0.25}^{+0.2}$, $15_{-0.25}^{+0.2}$, $20_{-0.25}^{+0.2}$, $25_{-0.25}^{+0.2}$, $35_{-0.25}^{+0.2}$ and $40_{-0.25}^{+0.2}$ kV by controlling them with indications of kilovoltmeter.

CAUTION! DO NOT HOLD THE BUTTON  MORE THAN 20 SECONDS DURING INCREASING TEST VOLTAGES MORE THAN 30 KV!

u) repeat the procedure from "k" to "t" in the power supply voltage of 210 V and 235 V;

v) disconnect the power supply cable from the power supply line, set the power switch  to "O" position.

6.6.4.2 Verification of reduced error of measurement of the test voltage shall be considered as satisfied if the obtained values comply with specified.

6.7 Presentation of the results of attestation

6.7.1 Test report is the result of attestation. It includes:

- basic data on the test equipment;
- the composition of the Commission (committee);
- the date of the attestation;
- the conditions of attestation;
- the list of measuring instruments;
- the results of external examination;
- the results of measurements;
- the results of processing;
- the committee results of attestation.

6.7.2 Test report issued if attestation result is positive.

6.7.3 Previous Test report cancelled if attestation result is negative.

7 Storage

7.1 In terms of climatic factors influence, the device storage conditions conform to the ones of group C according to GOST 15150. Storage facilities should be exempted of any acid and other harmful impurities causing damage to the materials of the device.

Note: the Storage Group – closed and other premises with natural ventilation without artificially controlled climatic conditions where temperature fluctuations from +40 °C to minus 50 °C and relative humidity of 80 % at a temperature of 20°C.

Template-caliber kept lubricated with conservation grease US-2 GOST 1033-79, wrapped in waterproof paper and packed in for the parts and tools.

8 Transportation

8.1 Transportation laid installation is allowed only in the packing crate.

8.2 The device transportation conditions in terms of climatic factors influence should conform to the ones stipulated in this User Manual and storage conditions L1.2 in accordance with GOST 15150.

8.3 When transporting the unit without the transport packaging to avoid vibration and shock.

Certificate of acceptance

Oil Tester UIM-90 (220) UIM-90 (220) _____
(product name) (designation) (serial number)

is manufactured and accepted according to the standards outlined in the technical documentation and has been established as serviceable.

Manufacturing date _____
year, month, date

Head of Quality Department

signature clarification of signature

STAMP _____
year, month, date

WARRANTY

The manufacturer guarantees UIM-90 (220) "UIM.220.00.00.000", serial No _____ technical operability and compliance with the specifications within 12 month from the date of purchase (the shipping date), provided none of the operating rules and regulations are violated.

Warranty start date _____

Director _____

Head of quality dept _____